

THERMOCOUPLE THERMOMETER

Dual J-T-E-K[®]

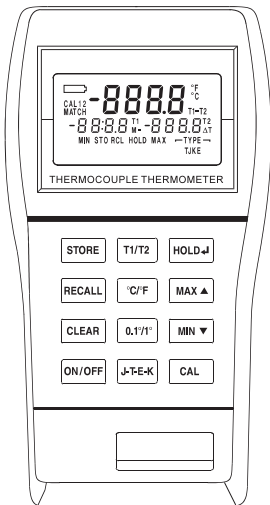

CERTIFICATE OF CONFORMANCE

This thermometer was calibrated using equipment traceable to the National Institute of Standards and Technology (NIST).

This instrument conforms to NIST monograph 175 revised to ITS-90.



The accuracy of the thermometer at the time of calibration was within specifications stated in the operating manual.

Model No.: _____

Serial Number: _____

Date placed in service: _____

To purchase an NIST certificate of traceability with test data and test date for meter and probe please contact your dealer or:

ISO 9001
REGISTERED

INTRODUCTION

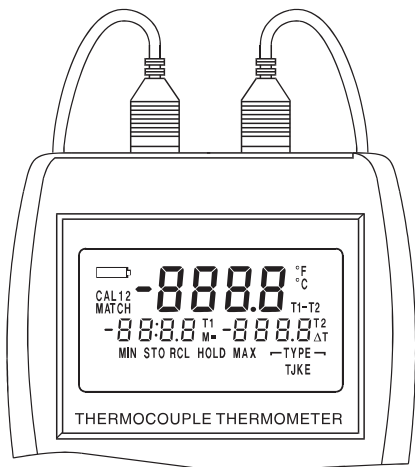

This versatile hand-held instrument provides highly accurate temperature measurements in Celsius, or Fahrenheit, using a wide range of thermocouple types. The temperature range for each type thermocouple is listed in the following chart.

TYPE	°C	°F
J	-200 to 1000	-328 to 1832
K	-250 to 1372	-418 to 2501
T	-250 to 400	-418 to 752
E	-250 to 1000	-418 to 1832

The instrument is designed for easy operation and includes the following features:

- Operator selection of temperature scale
- Resolution of 0.1° from –150°C to 999.9°C (–238°F to 999.9°F)
- LCD with three four-digit displays
- Two (2-blade female) ANSI mini-connector inputs
- Hold feature for temporarily retaining a reading
- Two-point field calibration capability
- Low battery warning
- Stores up to 25 readings
- Scrolls through all stored readings
- Displays MIN and MAX readings
- Scrolls between T1, T2, and T1-T2 readings
- Built-in tilt stand for easy hands-free operation

SAFETY PRECAUTIONS

⚠ WARNING *THIS INSTRUMENT IS DESIGNED TO ACCEPT LOW LEVEL SIGNALS SUPPLIED BY STANDARD THERMOCOUPLES. UNDER NO CIRCUMSTANCES SHOULD THE INPUT VOLTAGE EXCEED THE SPECIFIED 50V RMS.*

⚠ CAUTION *DO NOT USE OR STORE THIS INSTRUMENT IN MICROWAVE OVENS OR ANY ABNORMALLY HOT OR COLD AREAS.*

⚠ CAUTION *WEAK BATTERIES SHOULD NOT BE LEFT IN THE INSTRUMENT. DEAD BATTERIES CAN LEAK AND CAUSE DAMAGE TO UNIT.*

⚠ DANGER *VOLTAGES PRESENT AT THE THERMOCOUPLES MAY ALSO BE PRESENT AT THE BATTERY TERMINALS. ALWAYS DISCONNECT THE THERMOCOUPLE WHEN CHANGING BATTERIES.*

⚠ WARNING *TO PREVENT IGNITION OF A HAZARDOUS ATMOSPHERE, BATTERIES MUST ONLY BE CHANGED IN AN AREA KNOWN TO BE NON-HAZARDOUS.*

⚠ AVERTISSEMENT *AFIN DE PREVENIR L'INFLAMMATION D'ATMOSPHERES DANGEREUSES, NE CHANGER LES BATTERIES QUE DANS DES EMPLACEMENTS DESIGNES NON DANGEREUX.*

⚠ WARNING *TO PREVENT IGNITION OF A HAZARDOUS ATMOSPHERE BY ELECTROSTATIC DISCHARGE, CLEAN WITH DAMP CLOTH.*

SPECIFICATIONS

THERMOCOUPLE PROBES

Type	Temperature Range
------	-------------------

Type J: -200°C to 1000°C (-328°F to 1832°F)

Type K: -250°C to 1372°C (-418°F to 2501°F)

Type T: -250°C to 400°C (-418°F to 752°F)

Type E: -250°C to 1000°C (-418°F to 1832°F)

Accuracy $> -150^{\circ}\text{C}$: $\pm 0.1\%$ of reading, $\pm 0.4^{\circ}\text{C}$
($\pm 0.7^{\circ}\text{F}$)

Accuracy $< -150^{\circ}\text{C}$: $\pm 0.25\%$ of reading, $\pm 1^{\circ}\text{C}$
($\pm 2^{\circ}\text{F}$)

Linearization: Conforms to NIST monograph 175 revised to ITS-90.

Input Protection: 50V rms

Conversion Rate: Reading 0.6 seconds per update.

Connector: Two-blade female ANSI mini-connector inputs.

Battery

Size: Two AA, 1.5V alkaline ANSI-L40, IEC-LR6

Life: 750 hours continuous, typical

Display: LCD with 0.4 in high characters main readout and 0.2 in high characters secondary displays, 4 digits each display plus various annunciators.

Temperature/Humidity Range

Operating:

Stated Accuracy:	18°C to 28°C (64°F to 82°F)
Useful Range:	0°C to 40°C (32°F to 104°F)
Storage:	-40°C to 65°C (-40°F to 149°F)
Humidity:	10% to 90% (non-condensing)

Dimensions

3 cm D x 8.4 cm W x 15.8 cm H
(1.2 in x 3.3 in x 6.2 in)

Weight with batteries: 227 grams (8 ounces)

Ingress protection: Meets IEC-529 IP-54 for dust and water-resistant enclosures.

Intrinsic safety

This product is energy limited for intrinsically safe operation in hydrogen atmospheres per Class I, Division 1, Groups A, B, C, and D hazardous (classified) locations for UL per UL913 and CSA per C22.2 No. 0-M1982 and No. 157-M1987. Maximum surface temperature: 135°C (T4); UL file No. E182612 (1997).

Compliance (For CE Mark)

EN61326-1/A1: 1998 (EU EMC Directive)

BATTERY INSTALLATION AND REPLACEMENT

 **CAUTION** WEAK BATTERIES SHOULD NOT BE LEFT IN THE INSTRUMENT. DEAD BATTERIES CAN LEAK AND CAUSE DAMAGE TO UNIT.

 **DANGER** VOLTAGES PRESENT AT THE THERMOCOUPLES MAY ALSO BE PRESENT AT THE BATTERY TERMINALS. ALWAYS DISCONNECT THE THERMOCOUPLE WHEN CHANGING BATTERIES.

 **WARNING** TO PREVENT IGNITION OF A HAZARDOUS ATMOSPHERE, BATTERIES MUST ONLY BE CHANGED IN AN AREA KNOWN TO BE NON-HAZARDOUS.

 **AVERTISSEMENT** AFIN DE PREVENIR L'INFLAMMATION D'ATMOSPHERES DANGEREUSES, NE CHANGER LES BATTERIES QUE DANS DES EMPLACEMENTS DESIGNES NON DANGEREUX.

If battery indicator turns on, battery life is approximately 8 to 10 hours. The battery indicator will start blinking with less than 1 hour of life remaining.

AT THIS POINT BATTERY MUST BE CHANGED. IF BATTERY VOLTAGE GOES TOO LOW, DISPLAY WILL GO BLANK.

See SPECIFICATIONS for battery type.

1. Before changing battery, turn instrument off and disconnect thermocouple(s).
2. Loosen screw and lift battery cover off back of case.
3. Remove the two AA batteries.
4. Insert two new batteries observing polarity.
5. Install cover and tighten screw.

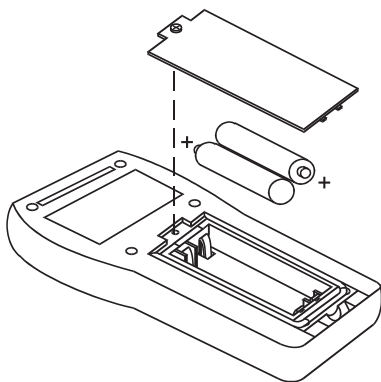

CONNECTING A THERMOCOUPLE

Note: Be sure your instrument setting (J, T, E or K) matches the thermocouple you are using.

Use the correct thermocouple type for your instrument. Using an incorrect thermocouple type will result in erroneous readings. Thermocouples are color coded by type using the North American ANSI color code as follows:

TYPE	COLOR
J	Black
K	Yellow
T	Blue
E	Purple

Thermocouple connectors have one wide blade and one narrow blade. *Do not force connector in backwards.* Connect thermocouple(s) to receptacle at top of instrument.

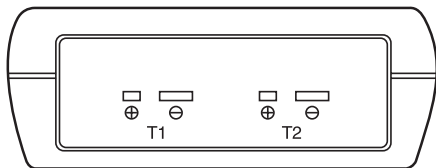





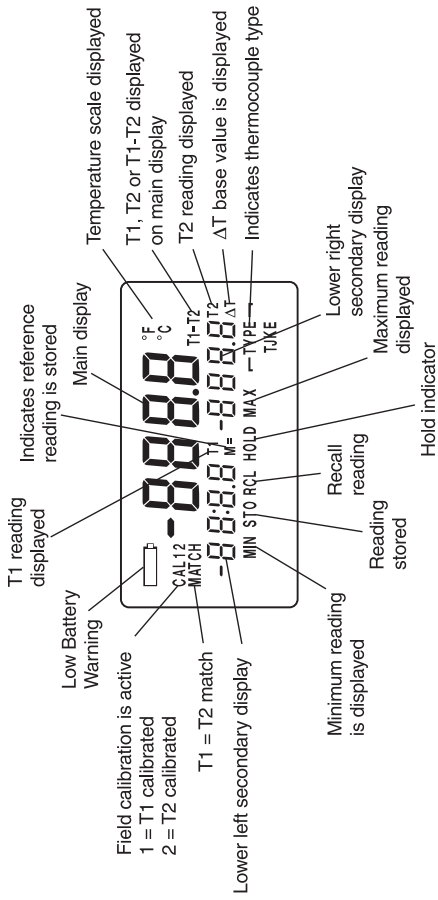

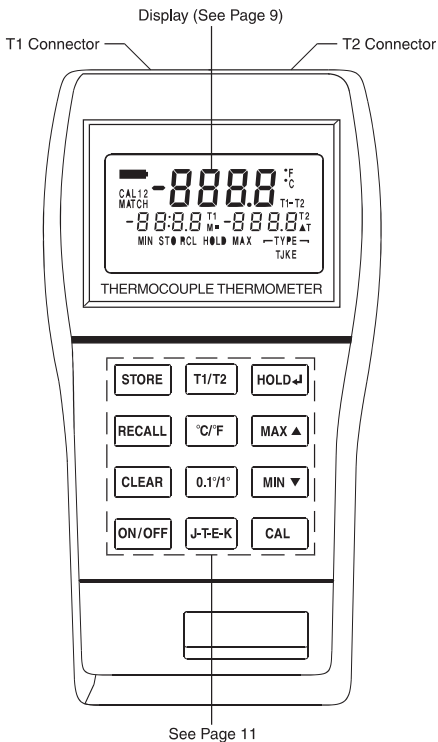
If only one thermocouple is being used, it can be connected to either T1 or T2. The thermometer will automatically determine which connector is being used. When two thermocouples are used, connect one to the T1 connector and one to the T2 connector.

Thermocouple wiring polarity must be correct. If readings decrease as the temperature increases, the thermocouple wires may be reversed. The red wire is negative for thermocouple wires manufactured in North America.





- STORE** — Press to store up to 25 readings.
- T1/T2** — Press to scroll main display between T1, T2, and T1-T2.
- HOLD**  — Press to freeze the current reading in display. (See field calibration section for  function.)
- RECALL** — Press to enter recall mode.
- °C/°F** — Press to select between °C and °F.
- MAX**  — Press to see the maximum reading. (See field calibration and recall sections for  function.)
- CLEAR** — Press to erase maximum, minimum, or stored readings.
- 0.1°/1°** — Press to see desired resolution.
- MIN**  — Press to see the minimum reading. (See field calibration and recall sections for  function.)
- ON/OFF** — Press to power up or turn off.
- J-T-E-K** — Press to select desired thermocouple type. (Scrolls through J-T-E-K.)
- CAL** — For field calibration. (See field calibration section.)

QUICK SETUP

Note: Review warnings on page 6.

1. Install batteries.
2. Connect thermocouple(s).
3. Press the **ON/OFF** key. The thermometer performs a self-test and all display digits and indicators, as shown below, should remain on for approximately one second.
4. Use **J-T-E-K** key to select the correct thermocouple and the **°C/°F** key to select the desired scale.

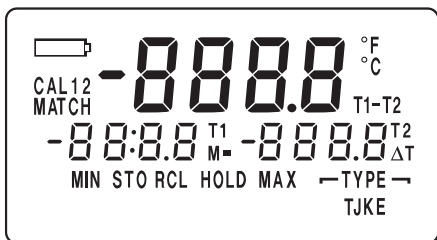

If a thermocouple has not yet been connected to one or more inputs on the instrument, you will see this display:



This message also appears if a thermocouple is broken. No measurements can be made while this warning is displayed.

COMPLETE SETUP PROCEDURE

The setup procedure is used to select the temperature scale, resolution, and thermocouple type.

NOTE

Selected settings are stored in memory and will remain in memory even after power is turned off, or while batteries are being replaced.

SELECTING TEMPERATURE SCALE

Select °C or °F by pressing the **°C/°F** key. Each time the key is pressed the temperature scale will switch. Switching between °C and °F can be done at any time during operation.

Each time you turn the instrument on, it will power up with the same settings that were set when the unit was last turned off.

SELECTING RESOLUTION

Select 0.1° or 1° resolution by pressing the **0.1°/1°** key. This key toggles between the two resolutions. When measuring temperature above 999.9° or below -150°C the thermometer automatically autoranges to 1° resolution.

SELECTING THERMOCOUPLE TYPE

Select the thermocouple type, either J, T, E, K, by pressing the **J-T-E-K** key. Each push of the key will step to the next type thermocouple. The selected thermocouple type is indicated by the annunciators in the lower right corner of the display.

Continue with the OPERATING PROCEDURES section or turn the instrument OFF by pressing the **ON/OFF** key again. The display will blank.

OPERATING PROCEDURES

The unit will always power up with the upper display showing T1 unless T1 is not connected. If only T2 is connected at power up, the upper display shows T2 and the lower left display indicates T1 is open. If thermocouples are not connected to T1 or T2 at power up, the upper display indicates an open T1 and the lower right display indicates an open T2.

If you are in single probe mode and the probe is moved to the other connector or to restore the dual probe mode, turn power OFF then back ON.

For optimum operation, allow about one minute for ambient temperature stabilization. If the unit has been stored at an extreme ambient condition, more time may be needed.

BASIC TEMPERATURE MEASUREMENTS

Check that the thermometer is turned on, the probe(s) connected, the desired resolution 0.1° or 1° is selected, and the desired scale $^{\circ}\text{C}$ or $^{\circ}\text{F}$, is selected.

Single Probe Measurements

The thermometer will automatically determine if T1 or T2 connection is being used.

Initially the upper display will indicate the measured temperature and the annunciator will indicate which probe is making the measurement. One of the lower displays will indicate open and the annunciator will indicate which probe is open. Pressing the **T1/T2** key will cause the thermometer to go into the single probe differential mode described later.

Temperatures $> 999.9^{\circ}$ have a resolution of 1° and therefore no decimal will be present.

Dual Probe Measurements

The thermometer will automatically determine if one or two thermocouples are connected. When two thermocouples are connected, the upper main display will initially show T1 and the lower right display will show T2. Pressing the **T1/T2** key once will cause the upper display to show T2 and the lower left display to show T1. Pressing the **T1/T2** key again will cause the upper display to show T1-T2, the lower left display to show T1, and the lower right display to show T2.

MAXIMUM READINGS

The maximum reading function displays the maximum reading since power up or since the last time the clear function was used. The maximum reading function is ideal for monitoring unattended operations while continually displaying every temperature change that occurs. The maximum and minimum values are sensed and automatically stored until you are ready to observe the reading.

Do not turn the instrument OFF when a maximum or minimum temperature value may be needed; MAX/MIN memory contents will be lost. Factory Calibration will be maintained.

Single Probe Measurements

The displayed information depends on whether you are using a single probe in the dual probe mode or have changed to the single probe differential mode by pressing the **T1/T2** key.

If you are using a single probe and in the dual probe mode, momentarily press the **MAX ▲** key. The MAX annunciator turns on. If the probe is connected to T1 the maximum reading will be shown in the lower left display. If the probe is connected to T2 the maximum reading will be shown in the lower right display. If a higher maximum occurs while in the MAX mode, the higher reading will be displayed. To turn off the maximum reading, press the **MAX ▲** key again.

If you are in the single probe differential mode, momentarily press the **MAX ▲** key. The MAX and MIN annunciators turn on and both the maximum and minimum readings appear in the lower displays. The minimum will be on the left display and the maximum on the right display. If a higher maximum or lower minimum occurs while in the MAX mode, the higher reading will be displayed. To turn off the maximum reading, press the **MAX ▲** key again.

Dual Probe Measurements

Momentarily press the **MAX ▲** key. The MAX annunciator turns on, and both maximum T1 and T2 readings appear in the lower display. The T1 reading is on the left display and the T2 reading is on the right display. Press **MAX ▲** key again to cancel.

Clearing a Maximum Reading

Press the **CLEAR** key then the **MAX ▲** key. The maximum memory will be cleared.

MINIMUM READINGS

The minimum reading function displays the minimum reading since power up or since the last time the clear function was used. While continually displaying every temperature change that occurs, the maximum and minimum values are sensed and automatically stored until you are ready to observe the reading.

Do not turn the instrument OFF when a maximum or minimum temperature value may be needed; MAX/MIN memory contents will be lost.

Single Probe Measurements

The displayed information depends on whether you are using a single probe in the dual probe mode or have changed to the single probe differential mode by pressing the **T1/T2** key.

If you are using a single probe and in the dual probe mode, momentarily press the **MIN ▼** key. The MIN annunciator turns on. If the probe is connected to T1 the minimum reading will be shown in the lower left display. If the probe is connected to T2 the minimum reading will be shown in the lower right display. If a lower minimum occurs while in the MIN mode, the lower reading will be displayed. To turn off the minimum reading, press the **MIN ▼** key again.

If you are in the single probe differential mode, momentarily press the **MIN ▼** key. The MAX and MIN annunciator turns on and both the maximum and minimum readings appear in the lower displays. The minimum will be on the left display and the maximum on the right display. If a lower minimum or higher maximum occurs while in the MIN mode, the new readings will be displayed. To turn off the minimum reading, press the **MIN ▼** key again.

Dual Probe Measurements

Momentarily press the **MIN ▼** key. The MIN annunciator turns on, and both minimum T1 and T2 readings appear in the lower display. The T1 reading is on the left display and the T2 reading is on the right display. Press the **MIN ▼** key again to cancel.

Clearing a Minimum Reading

Press the **CLEAR** key then press the **MIN ▼** key. The minimum memory will be cleared.

DIFFERENTIAL READINGS (T1-T2)

The differential function is used to compare two different measurements and display the difference between them. Differential measurements can be made using either one probe or two probes.

Single Probe Measurements



For single probe measurements, one measurement is stored as the reference measurement, then each following measurement is compared to the reference. The reference measurement is viewed on the lower left display, the differential value is shown in the lower right display and the main display shows the present T1 or T2 reading.

1. Place probe at first measurement point.
2. Press the **T1/T2** key to store this reference temperature. The ΔT and M= annunciators will be on and the reference temperature will be displayed on the lower left display. The ΔT indicates that the differential mode is selected and the M= indicates that a reference temperature has been stored. Any time after this that the **T1/T2** key is pressed, the M= value will be updated to the present value shown in the main display.
3. Place the probe at the second measurement point. The main display will immediately show the new measured temperature and the lower right display will immediately show the difference between the reference temperature and the present temperature point.



Dual Probe Measurement

1. Connect the two probes to the two points of measurement. The lower left display will indicate the T1 temperature, the lower right display will indicate the T2 temperature.
2. The main display can be scrolled between displaying T1, T2 or the differential temperature T1-T2 by repeatedly pressing the **T1/T2** key. To display the differential temperature press the **T1/T2** key until the T1-T2 annunciator to the right of the main display is on.

HOLD FUNCTION



Press the **HOLD**  key to retain the reading on the display. Press **HOLD**  key again for normal operation.

Maximum/Minimum Hold Readings

Press the **MAX**  key, then press the **HOLD**  key. To turn off the HOLD function and return to normal operation, press the **HOLD**  key again.

To clear the maximum readings, press the **CLEAR** key, then the **MAX**  key.

Minimum/Hold

Press the **MIN**  key, then press the **HOLD**  key. To turn off the HOLD function and return to normal operation press the **HOLD**  key again.

To clear the minimum readings, press the **CLEAR** key, then the **MIN**  key.

STORED READINGS

The store function allows you to store up to 25 readings. Both T1 and T2 readings are stored. To store readings proceed as follows:

1. Momentarily press the **STORE** key. Both T1 and T2 are stored. The upper main display will momentarily show the storage location number and the STO annunciator will be on.

After three seconds the storage number will be replaced with the temperature reading but the STO annunciator remains on to indicate a temperature reading has been stored. The **STORE** key may be pressed as fast as once per second.

2. Repeat step 1 for all the points to be recorded up to a maximum of 25. Each time the **STORE** key is pressed the new reading will be stored and the upper main display will show the storage location number for about 3 seconds. After 25 stored readings, the next time the **STORE** key is pressed the main display will indicate FULL.

RECALL READINGS

This function allows the stored readings to be recalled. RECALL shows each stored reading individually. To recall readings proceed as follows:

1. Momentarily press the **RECALL** key, the first stored reading will be displayed on the lower display and the store number "1" will be displayed on the upper display. The STO, and RCL annunciators will be on.
2. To step through the readings, press the **MIN ▼** key or the **MAX ▲** key. Each press of the key will advance to the next reading in sequence.
3. To return to normal operation press any other key except **ON/OFF**, **MAX ▲**, **MIN ▼** or **RECALL**.

Clearing Stored Readings

Press the **CLEAR** key, then the **STORE** key. The stored readings in memory will be cleared.

CALIBRATION

The calibration function allows both single point and dual point calibration of the thermometer. Single point calibrates the offset only. Dual point calibrates the offset first then calibrates the slope. The thermometer can be calibrated at any temperature. When two probes are used, a match calibration matches the T1 and T2 offsets.

It is not necessary to perform a field calibration to obtain specified accuracies. Use the calibration feature to improve thermometer/probe accuracy or to compensate for thermocouple probe calibration drift.

The thermometer has a memory retention capability to hold calibration values even while power is off or the battery is removed.

When you restart, there is no need to recalibrate. Each of the four thermocouple types may be individually calibrated and stored.

NOTE

The temperature at which water boils (100°C/212°F) is at sea level and standard atmospheric pressure using distilled water. Changes in altitude and barometric pressure will cause the boiling temperature to change.

As a general rule, the boiling temperature of water will decrease 1°C (1.8°F) for every 1000 feet above sea level. For example, at an elevation of 5300 feet (1600 meters), water will boil at approximately 94.7°C (202.5°F).

Other liquids may also be used as calibration standards. Consult a chemical handbook for their freezing (melting) point and boiling point properties.

When calibrating at freezing (0°C or 32°F) it is recommended to use crushed ice made of distilled water in a dewar flask. Add crushed ice to top of flask. Top off flask with distilled water. Continue to add crushed ice to maintain tightly packed crushed ice/water in flask.

CALIBRATION PROCEDURES

Calibration Procedure (One Probe Detected)

This calibration function provides for both an offset and slope field calibration of either T1 or T2. If only one probe is detected, the procedure applies to that probe, and the main display will indicate T1 or T2 as applicable. For proper calibration the following conditions must be observed:

- The slope point must be a higher temperature than the offset point.
- The difference must be at least 20°C.
- Use two points based on the expected high and low temperatures. Temperatures measured outside of these limits may no longer meet accuracy specifications.

Proceed as follows to calibrate the probes.

1. Place the probe at the lower known reference temperature.
2. **Offset Calibration:** Momentarily press the **CAL** key to enter the calibration mode, the CAL annunciator will flash. The temperature is displayed on the main display and Lo is displayed on the lower left display. "Lo" signifies that this is the offset point.

3. Allow the reading to stabilize. If the displayed temperature is higher or lower than the reference temperature, use the **MAX ▲** key to increase the displayed reading or the **MIN ▼** key to decrease the displayed reading until the reference temperature is displayed. **The MIN ▼ or MAX ▲ key must be pressed at least once.** The CAL annunciator should be blinking during this procedure.
4. Press the **HOLD ◀** key to lock the offset calibration in and advance to the slope calibration. To return to normal operation press any key except **CAL** or **HOLD ◀**.
5. **Slope Calibration:** Place the probe at the higher reference temperature.
6. Allow the reading to stabilize. If the displayed temperature is higher or lower than the reference temperature, use the **MAX ▲** key to increase the displayed reading or the **MIN ▼** key to decrease the displayed reading until the reference temperature is displayed. **The MIN ▼ or MAX ▲ key must be pressed at least once.** The CAL annunciator should be blinking during this procedure.
7. Press the **HOLD ◀** key to lock the calibration in.

Calibration Procedure (Two Probes Detected)

This calibration function provides for both an offset and slope field calibration of either or both T1 and T2. For proper calibration the following conditions must be observed:

- The slope point must be a higher temperature than the offset point.
- The difference must be at least 20°C.
- Use two points based on the expected high and low temperatures. Temperatures measured outside of these limits may no longer meet accuracy specifications.



Proceed as follows to calibrate the probes.

1. Place the probe at the lower known reference temperature.
2. **Offset Calibration:** Momentarily press the **CAL** key to enter the calibration mode, the CAL annunciator will flash. The temperature is displayed on the main display and Lo is displayed on the lower left display. "Lo" signifies that this is the offset point.
3. Allow the reading to stabilize. If the displayed temperature is higher or lower than the reference temperature, use the **MAX ▲** key to increase the displayed reading or the **MIN ▼** key to decrease the displayed reading until the reference temperature is displayed. **The MIN ▼ or MAX ▲ key must be pressed at least once.** The CAL annunciator should be blinking during this procedure.
4. Press the **HOLD ◀** key to lock the T1 calibration in and advance to T2 offset calibration, or press the **CAL** key to skip T1 calibration. In either case you will now be in T2 offset calibration.

5. Allow the reading to stabilize. If the displayed temperature is higher or lower than the reference temperature, use the **MAX ▲** key to increase the displayed reading or the **MIN ▼** key to decrease the displayed reading until the reference temperature is displayed. **The MIN ▼ or MAX ▲ key must be pressed at least once.** The CAL annunciator should remain blinking during this procedure.
6. Press the **HOLD ↵** key to lock the T2 offset calibration in, or press the **CAL** key to skip T2 offset calibration and proceed with T1 slope.

If T1 or T2 offset calibration is skipped, then the slope calibration for that input will also be skipped.

7. **Slope Calibration:** Place the probe(s) at the higher reference temperature.
8. The temperature is displayed on the main display and "Hi" is displayed on the lower left display.
9. Allow the reading to stabilize. If the displayed temperature is higher or lower than the reference temperature, use the **MAX ▲** key to increase the displayed reading or the **MIN ▼** key to decrease the displayed reading until the reference temperature is displayed. **The MIN ▼ or MAX ▲ key must be pressed at least once.** The CAL annunciator should remain blinking during this procedure.
10. Press the **HOLD ↵** key to lock the T1 slope calibration in and advance to T2 slope calibration, or press the **CAL** key to skip T1 slope calibration. In either case you will now be in T2 slope calibration.

11. Press the **HOLD**  key to lock the T2 slope calibration in, or press the **CAL** key to skip T2 slope calibration. In either case you will now be in T1 = T2 offset calibration. To return to normal operation press any key except **CAL** key or **HOLD**  key.

If either T1 or T2 offset or slope were modified, CAL 1 or 2 will be lit.

12. The MATCH annunciator should be blinking. When both readings (T1 and T2) are stable, press the **HOLD**  key to lock the T1 = T2 offset calibration in. The MATCH annunciator will remain lit.

13. This completes the two-point calibration.

14. To return to normal operation press any key except **ON/OFF** key or the **CAL** key.

Matching T1 and T2 Procedure

This procedure requires both probes to be at the same temperature.

1. Place both probes at the same temperature and let stabilize.

2. Momentarily press the **CAL** key until the MATCH annunciator is blinking. When both readings (T1 and T2) are stable, press the **HOLD**  key to lock in the calibration.

Clearing an Individual Cal Point: Press **CAL** key until the desired point is displayed, then press **CLEAR** key.

Clearing all Cal Points: Press **CLEAR** key, then **CAL** key. Unit reverts to factory calibration with no offset or slope compensation.



FIELD CALIBRATION LOCKOUT AND RE-ENABLE

The calibration lockout feature, prevents any field calibration changes. The lockout remains in effect until a lockout re-enable has been performed. Use the following procedures to lockout or re-enable the field calibration operation.

Lockout Procedure

1. Turn the thermometer off.
2. Simultaneously press and hold the **CAL** and the **CLEAR** keys down and momentarily press the **ON/OFF** key. Continue to hold the **CAL** and **CLEAR** keys for at least 5 seconds.

Re-Enable Procedure

1. Turn the thermometer off.
2. Simultaneously press and hold the **HOLD**  and the **CAL** keys down and momentarily press the **ON/OFF** key. Continue to hold the **HOLD**  and **CAL** keys until the display blanks.

MAINTENANCE AND TROUBLESHOOTING

Properly used, the thermometer should maintain calibration indefinitely and not require service other than occasional cleaning of the housing and changing of the batteries.



WARNING

TO PREVENT IGNITION OF A HAZARDOUS ATMOSPHERE BY ELECTROSTATIC DISCHARGE, CLEAN WITH DAMP CLOTH.

Do not clean with abrasives or solvents. Use mild detergents, never immerse nor use excessive fluid.

BATTERIES

If there is no display when the thermometer is turned on, check condition of the two AA batteries. Also check that the battery terminals are clean and batteries are properly installed. If replacement is necessary, refer to the BATTERY INSTALLATION AND REPLACEMENT section for replacement procedure.

All stored readings are retained until cleared, even if the batteries are removed for long periods.

SERVICE

⚠ WARNING *SUBSTITUTION OF COMPONENTS MAY IMPAIR INTRINSIC SAFETY.*

⚠ AVERTISSEMENT *LA SUBSTITUTION DE COMPOSANTS PEUT COMPROMETTRE LA SECURITE INTRINSEQUE.*

There are no internal adjustments or user replaceable parts.

If “Err” followed by the numbers 1 through 9 is displayed (see example below) return unit for service. Note that “Err” alone may be displayed during improper field calibration.

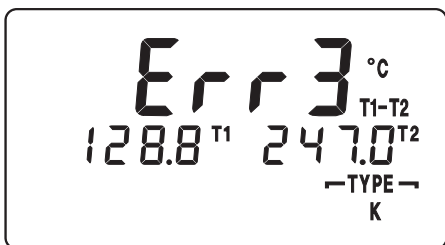

Note: Serial number label is located inside battery compartment.

TROUBLESHOOTING

The following chart lists the most probable faults. There are no internal adjustments or user-replaceable parts. If this does not solve the problem, refer service to your dealer.

FAULT	ACTION
No display when turned on.	Check condition of batteries. Check that batteries are inserted properly.
Display shows - - - -	Out of range indication.
Display shows OPEn	Open thermocouple connection.
Display shows Err	If displayed at any time other than during field calibration, return instrument for service.

If Err 1 through Err 9 remains on the display, return instrument for service.

EU Declaration of Conformity

Name of Apparatus: Dual J-T-E-K®
Thermocouple Thermometer

Model Number: 600-1040

Description of Apparatus: Electronic
Thermometer using a Thermocouple
Probe

_____ declares that the above
model is in conformity to the following
harmonized standards and directives:

Applicable Directives	Applicable Specifications	Manufacturer's Report Number
89/336/EEC 92/31/EEC 93/68/EEC	EN61326-1/A1: 1998	TR9648

WARRANTY

The Manufacturer warrants this product to be free from significant deviations from published specifications. If repair or adjustment is necessary within the warranty period, the problem will be corrected at no charge if it is not due to misuse or abuse on your part as determined by the Manufacturer. Repair costs outside the warranty period, or those resulting from product misuse or abuse, may be invoiced to you.

The warranty period for this product is noted on the Warranty Card.

PRODUCT RETURN

To limit charges and delays, contact the seller or Manufacturer for authorization and shipping instructions before returning the product, either within or outside of the warranty period. When returning the product, please state the reason for the return. For your protection, pack the product carefully and insure it against possible damage or loss. Any damages resulting from improper packaging are your responsibility.

TECHNICAL ASSISTANCE

If you have any questions about the use of this product, contact the Manufacturer or authorized seller.

Trademarks bearing the ® symbol in this publication are registered in the U.S. and in other countries.